

# Probabilistic Simulation of Waveguide Hybrid Junction in CST Studio Suite

Dr. The-Quan Pham<sup>1</sup>, Dr. Holger Neubert<sup>2</sup>, Dr. Alfred Kamusella<sup>2</sup>

<sup>1</sup> OptiY e.K. Germany

<sup>2</sup> TU Dresden, Institute of Electromechanical and Electronic Design, Germany

CST European User Group Meeting

March 16-18, 2009 in Darmstadt

## Design Challenges

### Variability, Uncertainty and Randomness

- A nominal Value of Design Parameter
- A arbitrary Stochastic Distribution

### Causes

- Manufacturing Inaccuracy
- Material Property Scattering
- Environment Influences
- Process Uncertainty
- Human Factors etc.

### Problems

- Rejection at Manufacturing
- Low Reliability, Bad Quality
- Problem with Customers Warranty

### Industry

- Prototypes (high time and cost effort)
- Design of Experiment

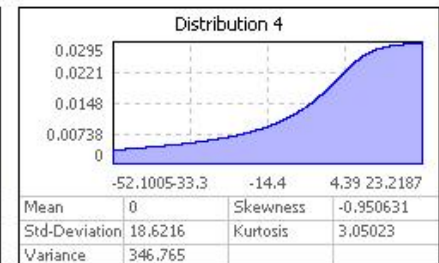
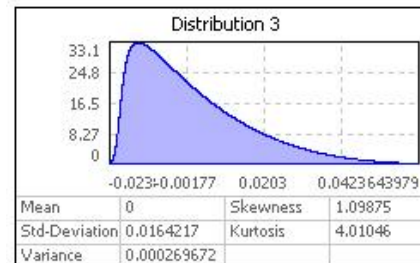
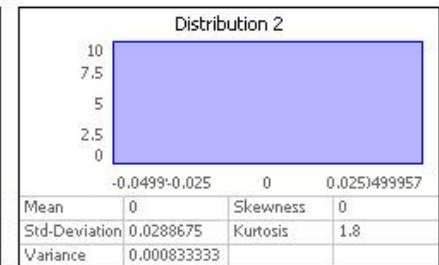
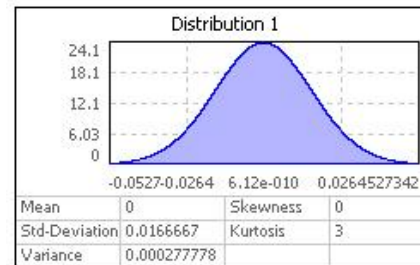
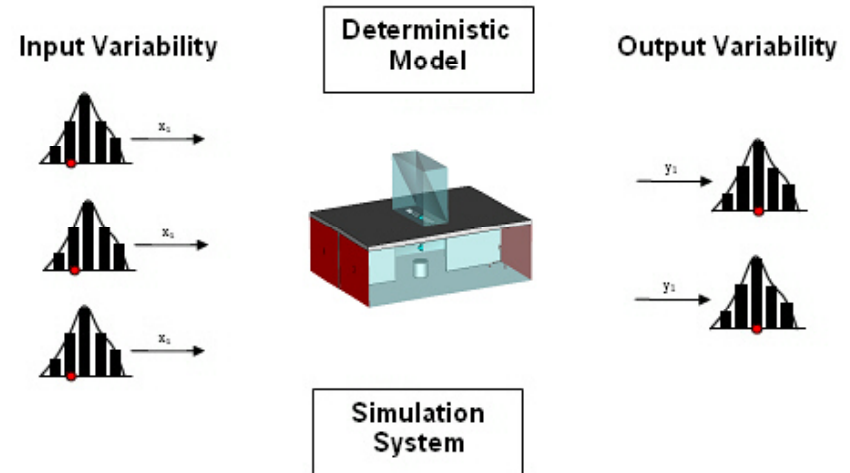

## Design for Reliability and Robustness

### **Robustness Evaluation**

- A good Product Quality is characterized by a small Change of Outputs due to the same Input Variability
- Robust Design evaluate the Variance of the Output Distributions:
  - A small Variance of Output = Robust Design
  - A large Variance of Output = Non-Robust Design

### **Reliability Analysis**

- Investigate the Violation of Constraint boundaries due to Input Variability
- Calculate the Rejection at a Mass Manufacturing Process based on the Probability Density Function (PDF)
- Design Goal: minimal Rejection (better Quality)

### **Sensitivity Study**

- Identify the important Influence Design Parameters
- Disregard insignificant Design Parameters
- Investigate Interactions between Input Parameters

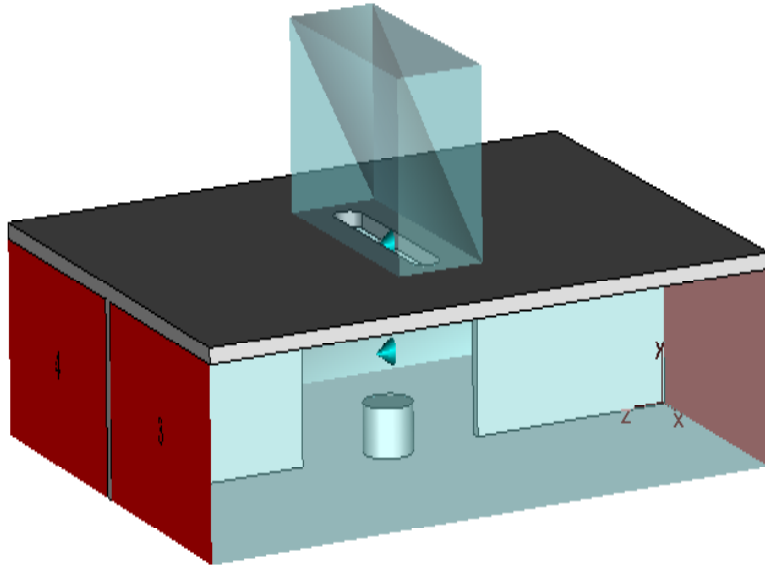

### Waveguide Hybrid Junction

- The structure contains a coupling section with a small metallic disk and an external cavity resonator connected to the waveguides by a coupling hole.
- Manufacturing tolerances have great influence on junction performance, reliability and quality

Design Parameter	Nominal Value	Tolerance Value	Distribution
Hole Length	19.655	0.6	Normal
Hole Width	3.016	0.6	Normal
Gap	19.081	0.6	Normal
Disk High	2.994	0.6	Normal
Disk Radius	2.511	0.6	Normal

### The Nominal Solution (Ideal Best-Case) Deterministic Simulation in CST Studio Suite

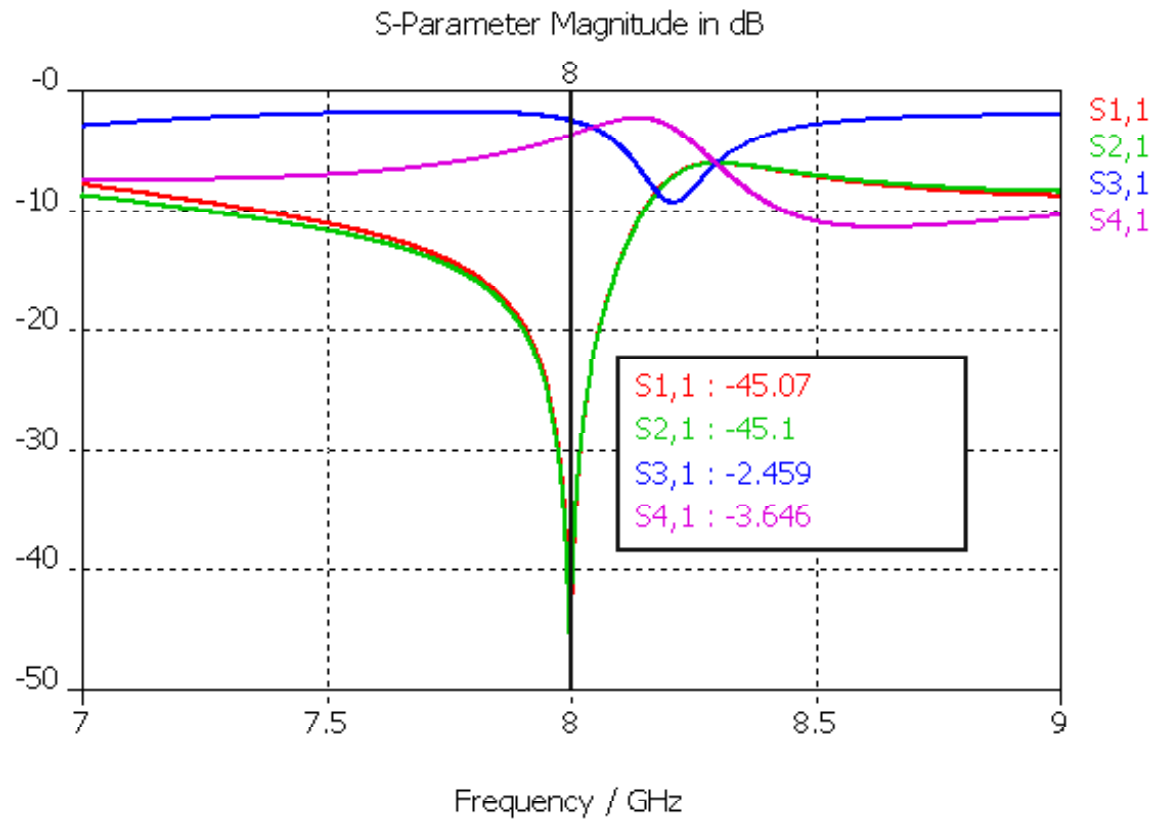

- The solution contains the following parameters:

Hole Length = 19.655  
 Hole Width = 3.016  
 Gap = 19.081  
 Disk High = 2.994  
 Disk Radius = 2.511

- The ideal operating point at 8 GHz is optimal (best case): maximal Transmission and minimal Reflection

### OptiY Workflow for Coupling with CST Studio Suite

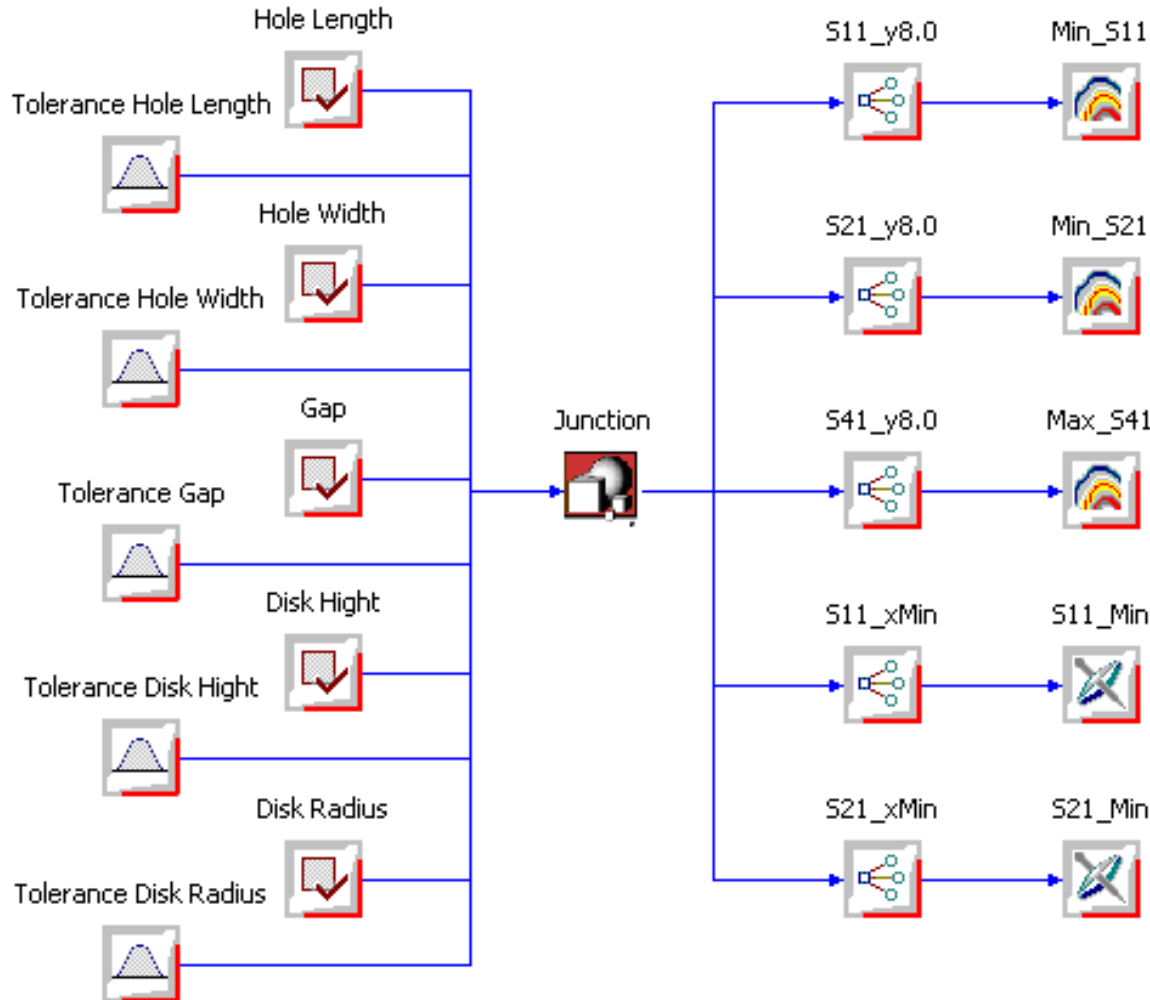

#### CST Studio Node in OptiY

- Easy of use

#### Design of Experiment:

- Second Order Moment
- 51 Model Calculations
- Reduced Second Order
- Without Interactions
- Only 11 Model Calculations

#### The goal is to explore the operating design point at 8 GHz:

- Customers requirement: reflection tolerance only 0.1 GHz (7.95 – 8.05 GHz)

## Robustness and Reliability of Reflection and Transmission

- The zero-reflection frequency: 7.9–8.1 GHz (specification: 7.95-8.05 GHz)
- 12.5% of all mass manufactured parts will fail the customers requirement
- Significant Worst Reflection at operating point 8GHz = 0.13 (linear)
- Significant Worst Transmission at operating point 8GHz = 0.55 (linear)

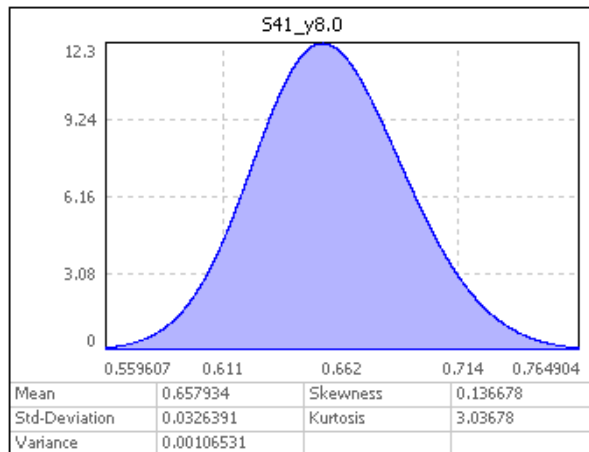

Transmission at 8 GHz  
 Mean: 0.657  
 Std Deviation: 0.0326

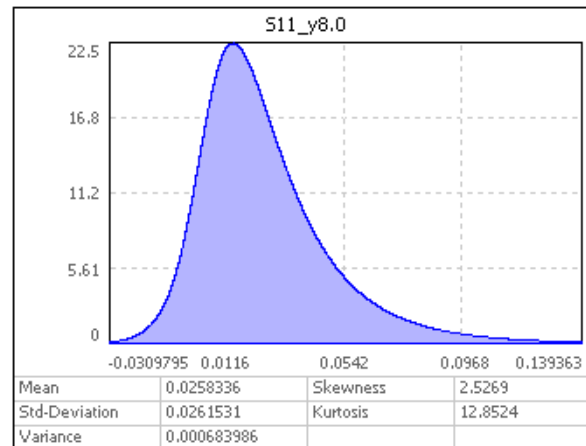

Reflection at 8 GHz  
 Mean: 0.0258  
 Std Deviation: 0.0261

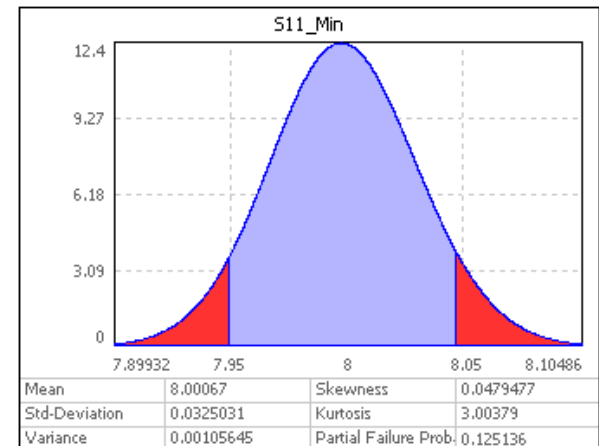

Zero-Reflection Frequency  
 Mean: 8.0  
 Std Deviation: 0.0325

## Sensitivity Study

- The Hole geometry tolerances (Length and Width) contribute the most to the variability of reflection and transmission. Its should be minimized to reduce the output variability
- The Disk geometry and the Gap are insignificant and can be eliminated from the model
- There are no interactions between inputs (main effect = total effect)
- Reduced Second Order as Design of Experiment being used to reduces number of model Calculations

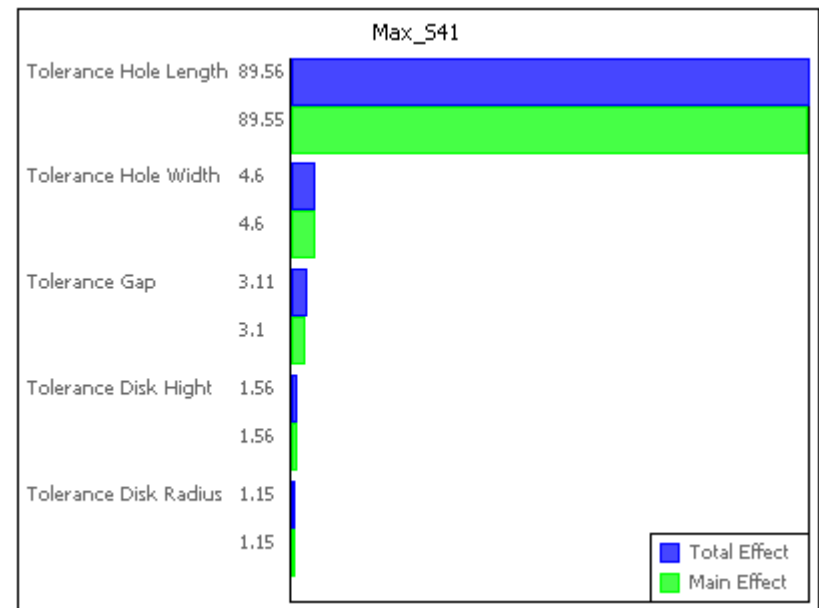
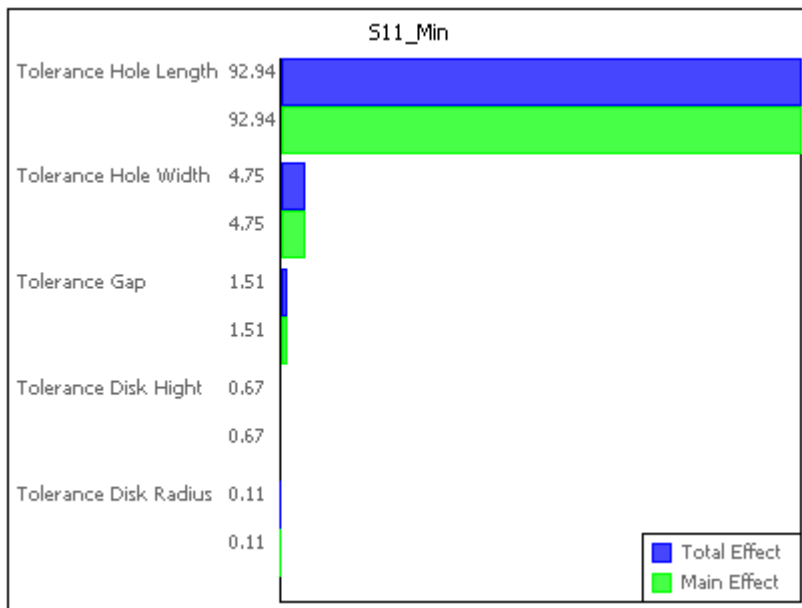

## Response Surface Modeling

- Graphical 2D and 3D Diagrams of the meta model
- The meta model visualized the entire design space
- Fast Robust Design Optimization with the meta model
- Best- and Worse-Case Simulation

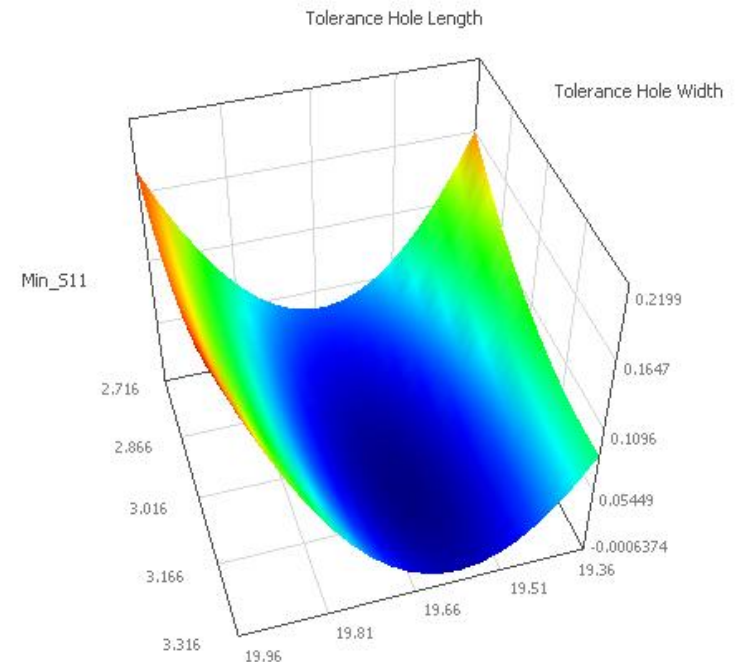
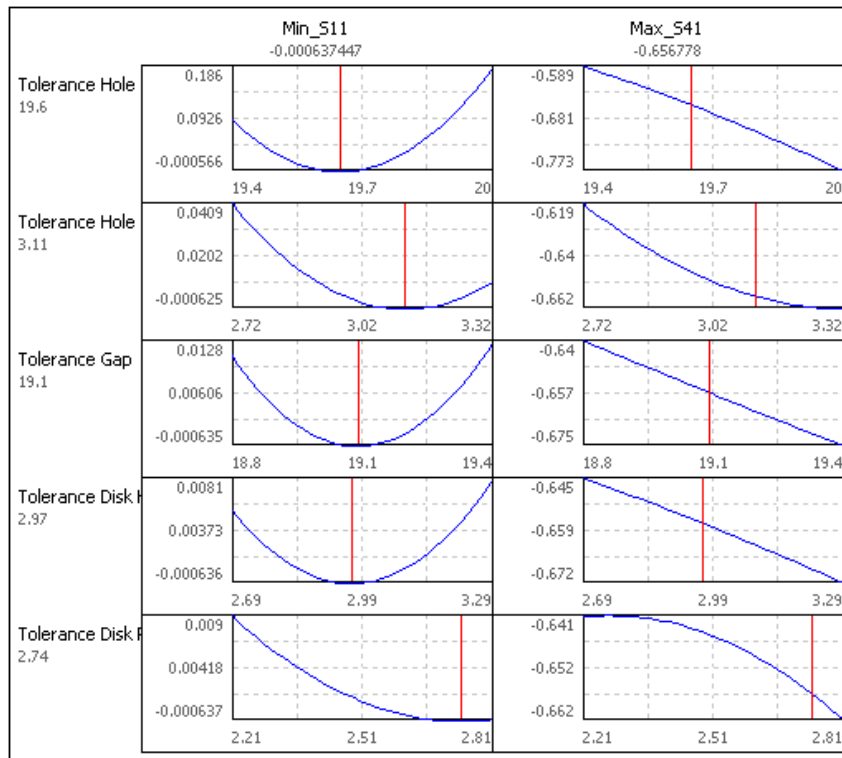

## Coefficients of the Response Surface Model

- The coefficients of the Taylor-series are shown
- representation as local sensitivities
- Export of the meta model into Matlab/C

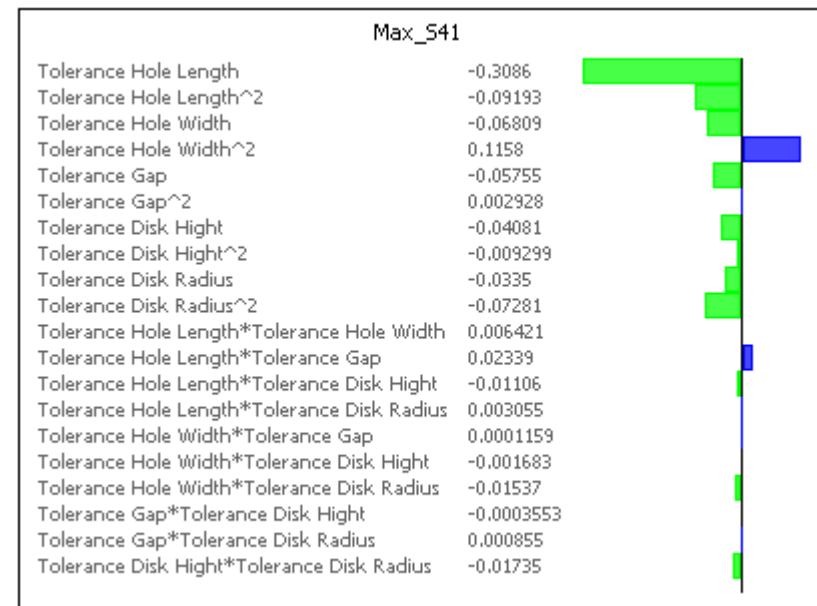
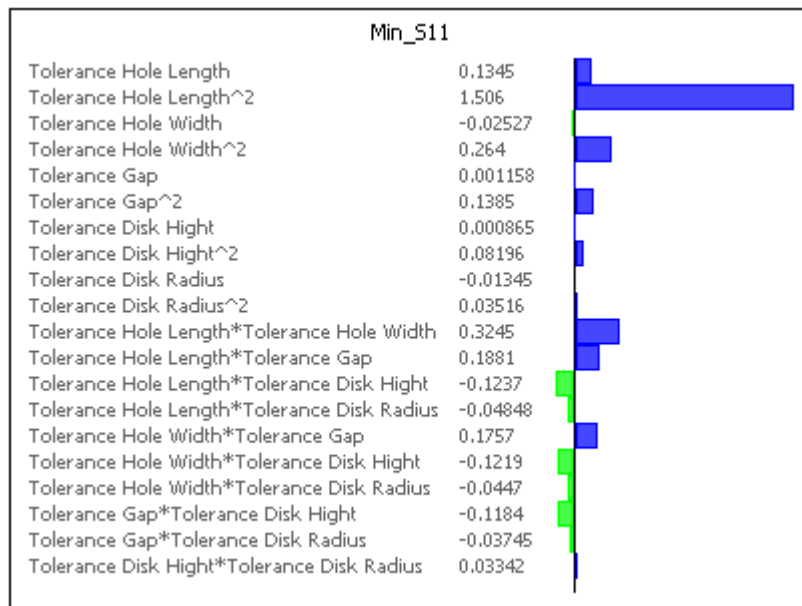

## The Worse-Case Simulation

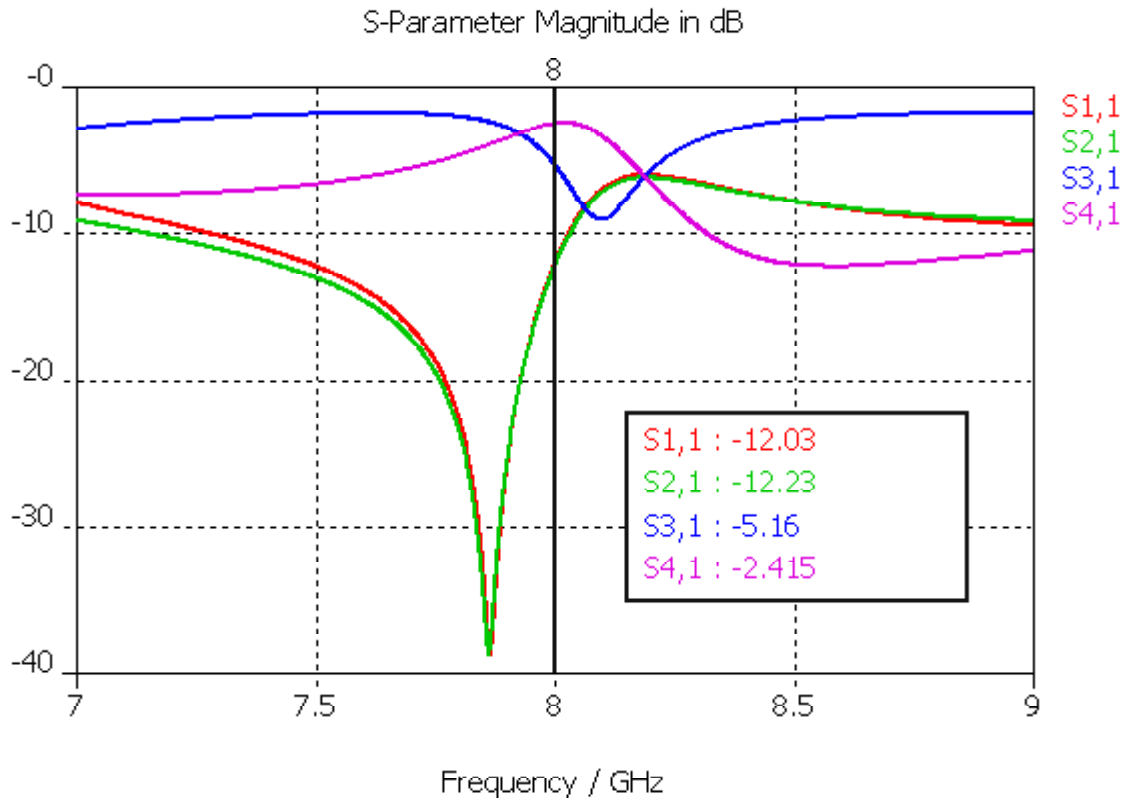

**The worse case solution within the tolerance space at the operating design point 8GHz:**

Reflection: -12 dB  
Transmission: -2.4 dB

**At the design parameter combination:**

Hole Length = 19.952  
Hole Width = 3.316  
Gap = 19.378  
Disk High = 2.698  
Disk Radius = 2.211

## Conclusions

- Variability, Uncertainty and Randomness play an important part in the Design Process for Reliability and Robustness
- Demonstration on the Hybrid Waveguide Junction shows the lack of deterministic Simulation today. Probabilistic Simulation brings the virtual Components closer to Reality
- Reliability and Robustness can be evaluated based on output variability
- Sensitivity Study can identify most influenced parameters to the output variability
- **OptiY** for probabilistic Simulation is easy to connect to **CST Studio Suite** deterministic Simulation